

CAMRON/BENTON - SPIEGEL

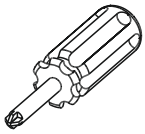

Ø8

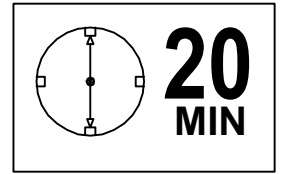
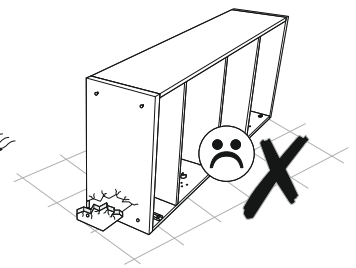
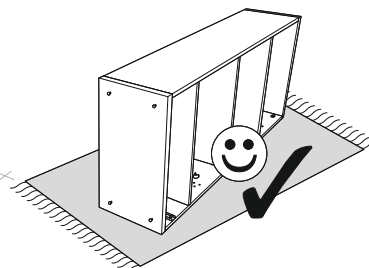
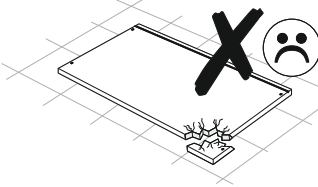
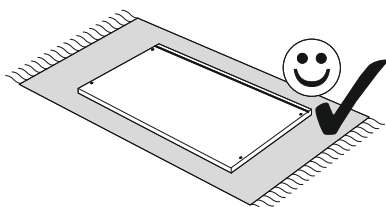
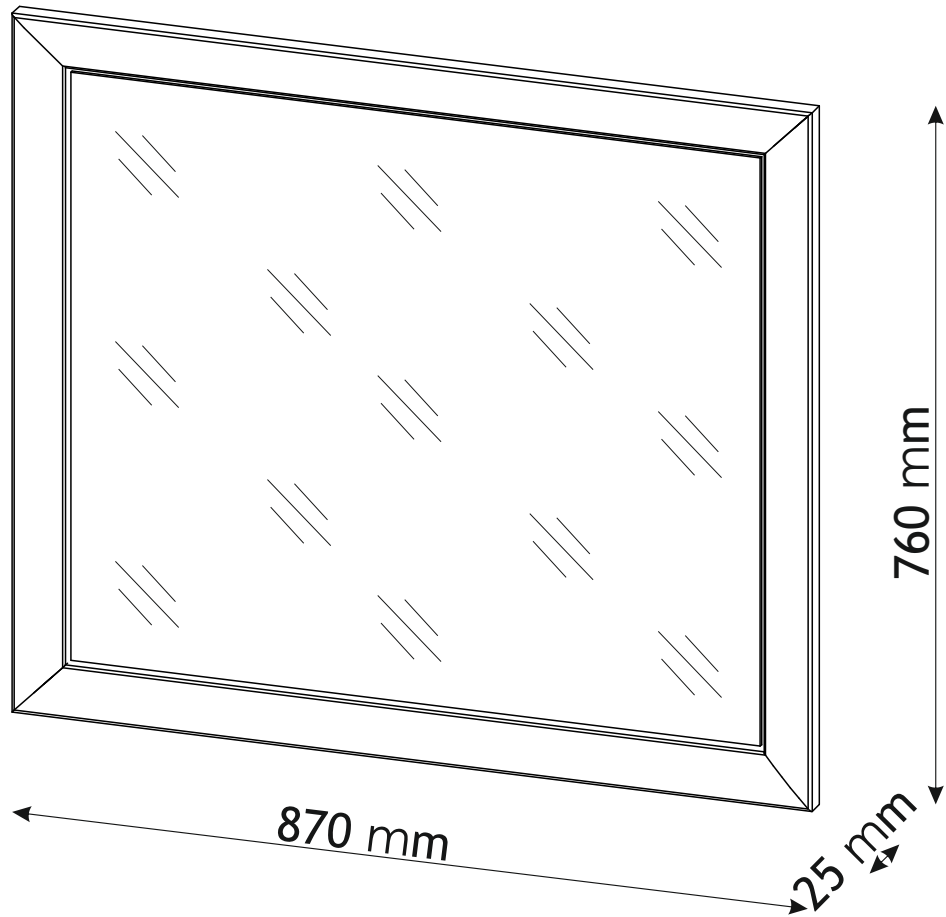
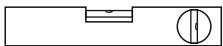

CAMRON/BENTON - SPIEGEL

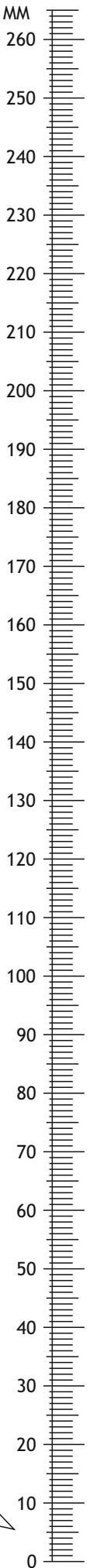

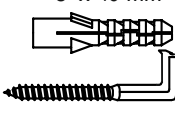
D22	5 x 11 mm	x4	E1	8 x 40 mm	x2
					

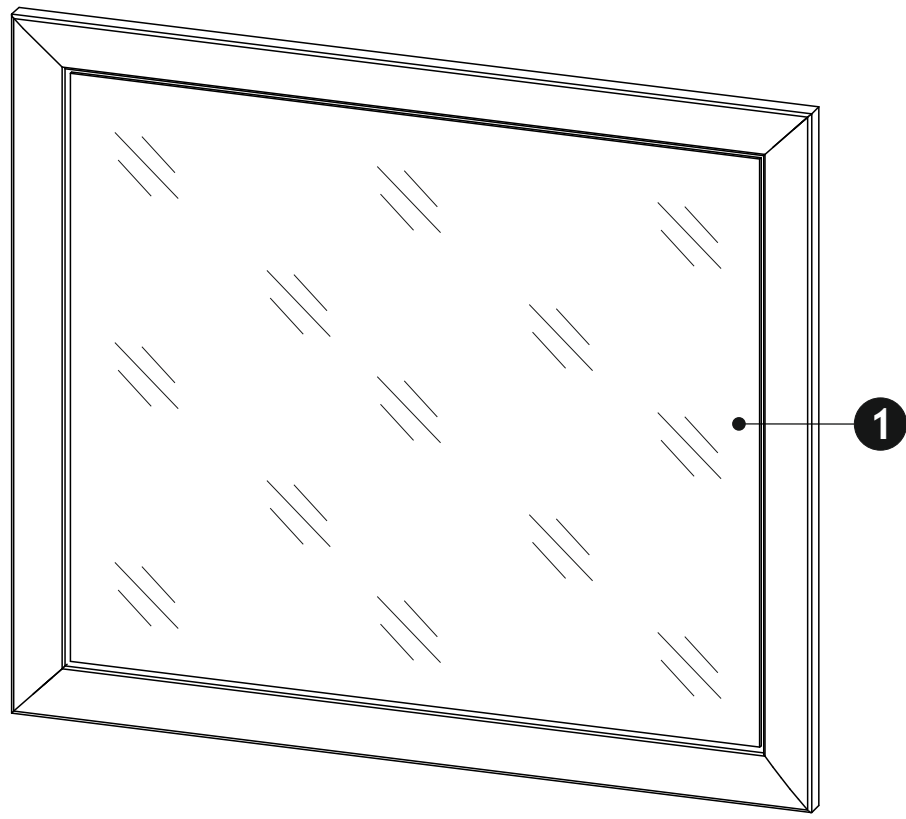

1	760	870	25	x1	1/1
					1/1

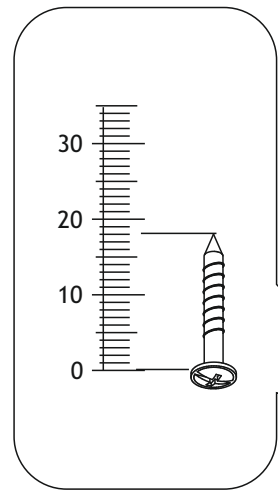

1 ▶

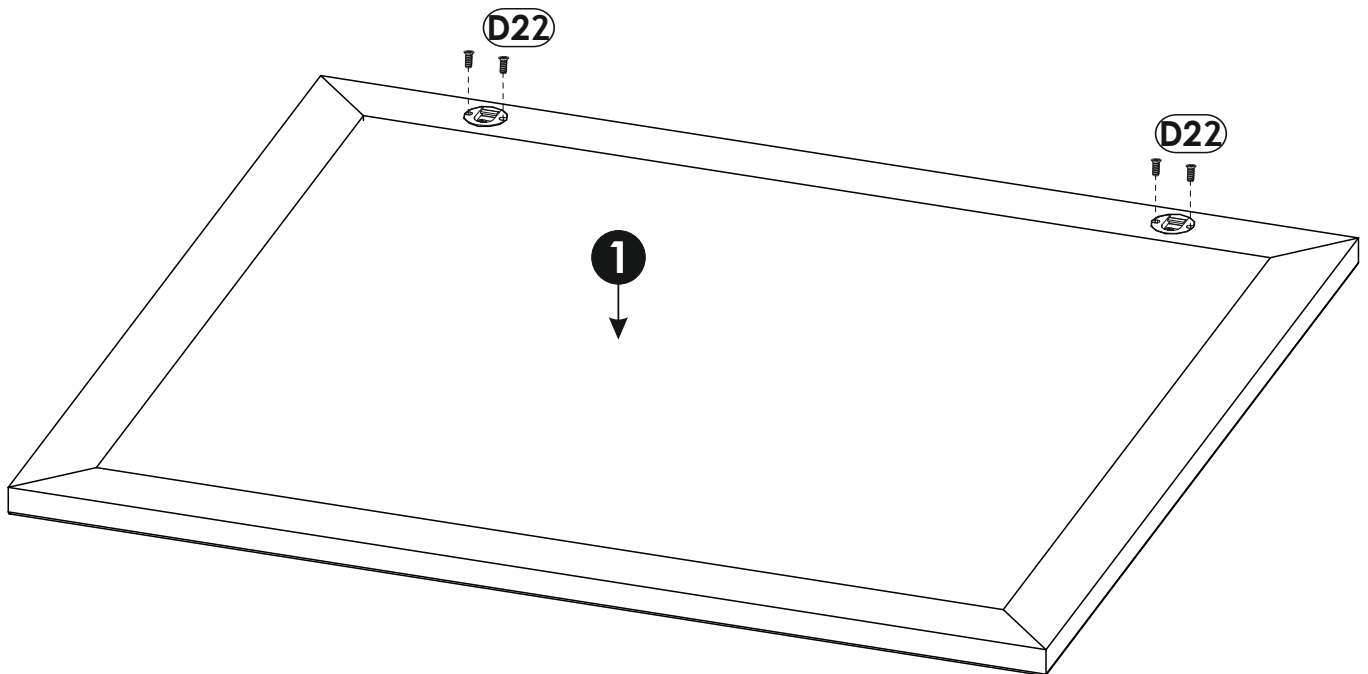
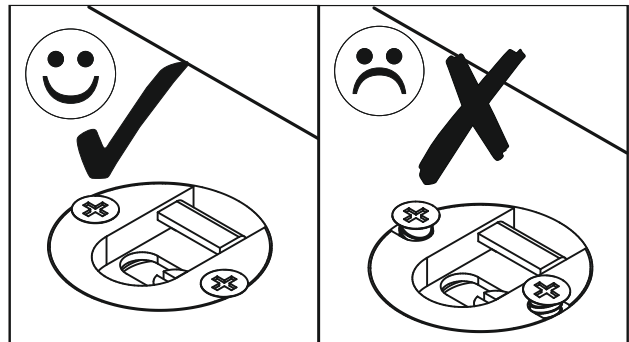
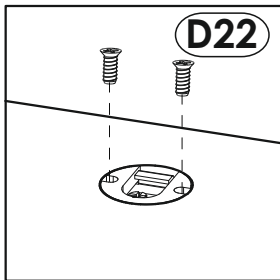
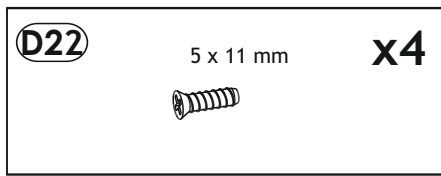

2 ▶

