

# HARVEY - SPIEGEL

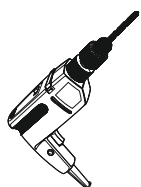

Ø8

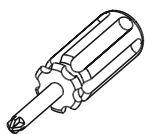
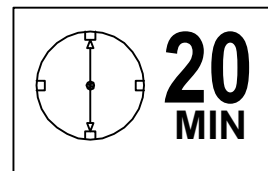
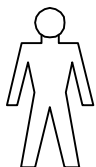
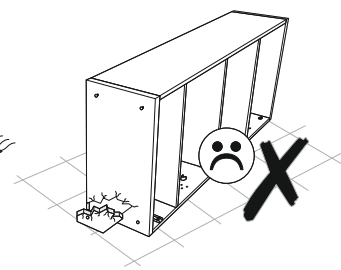
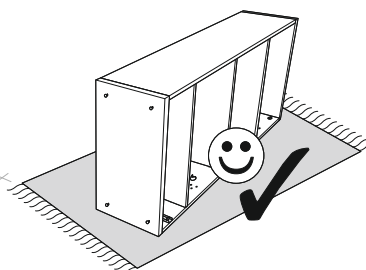
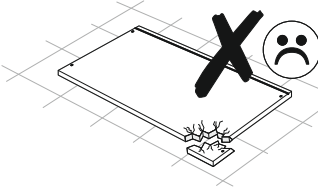
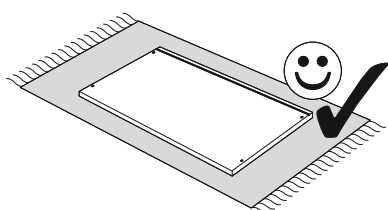
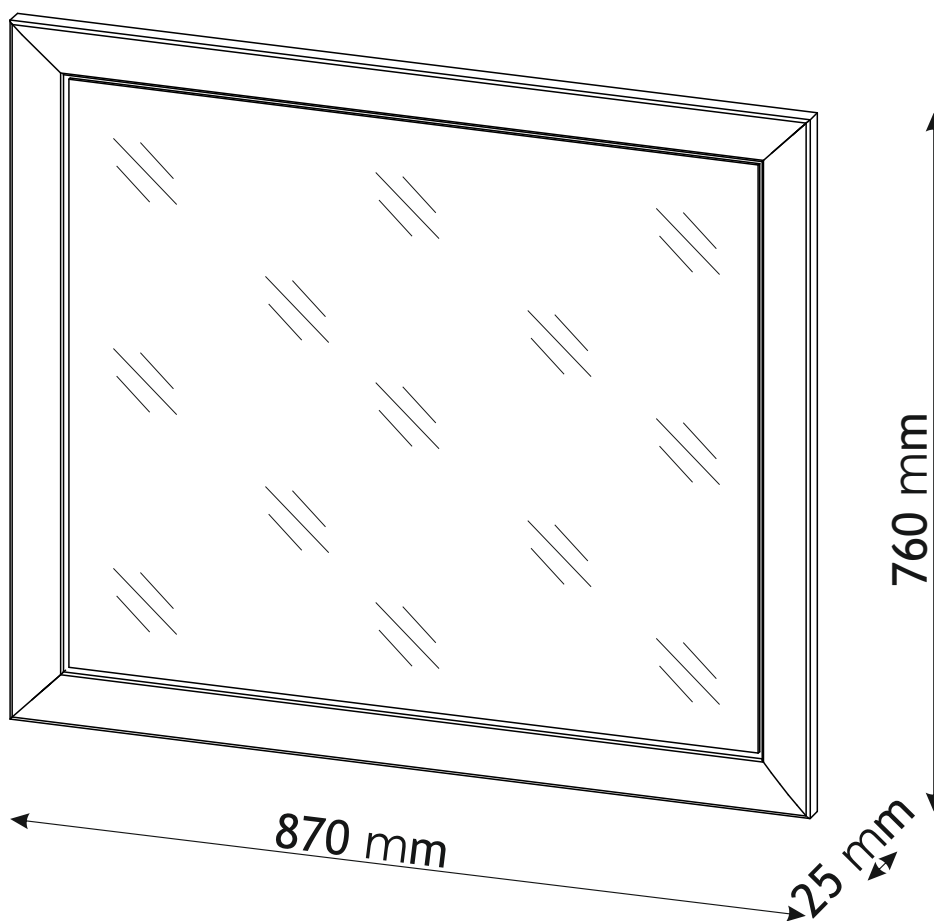

# HARVEY - SPIEGEL

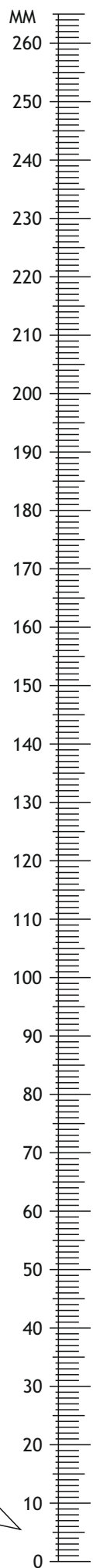

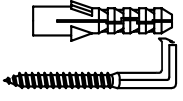
<b>D22</b>	5 x 11 mm	<b>x4</b>	<b>E1</b>	8 x 40 mm	<b>x2</b>
					

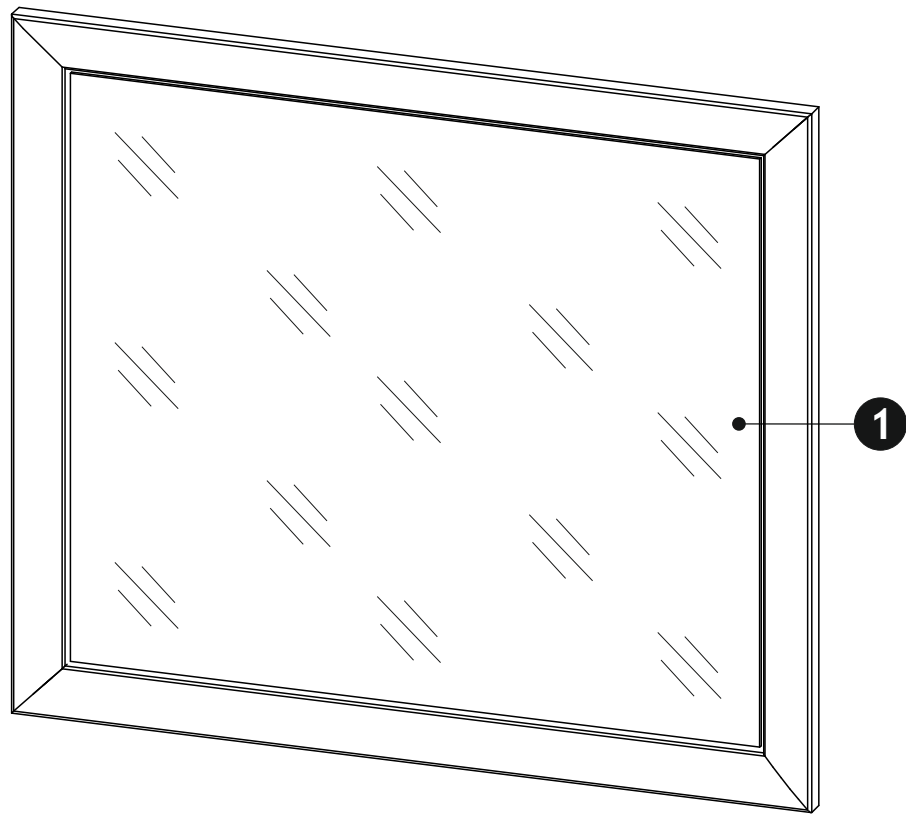

<b>1</b>	760	870	25	x1	1/1
					1/1

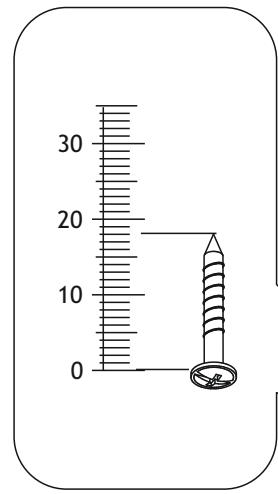

1 ▶

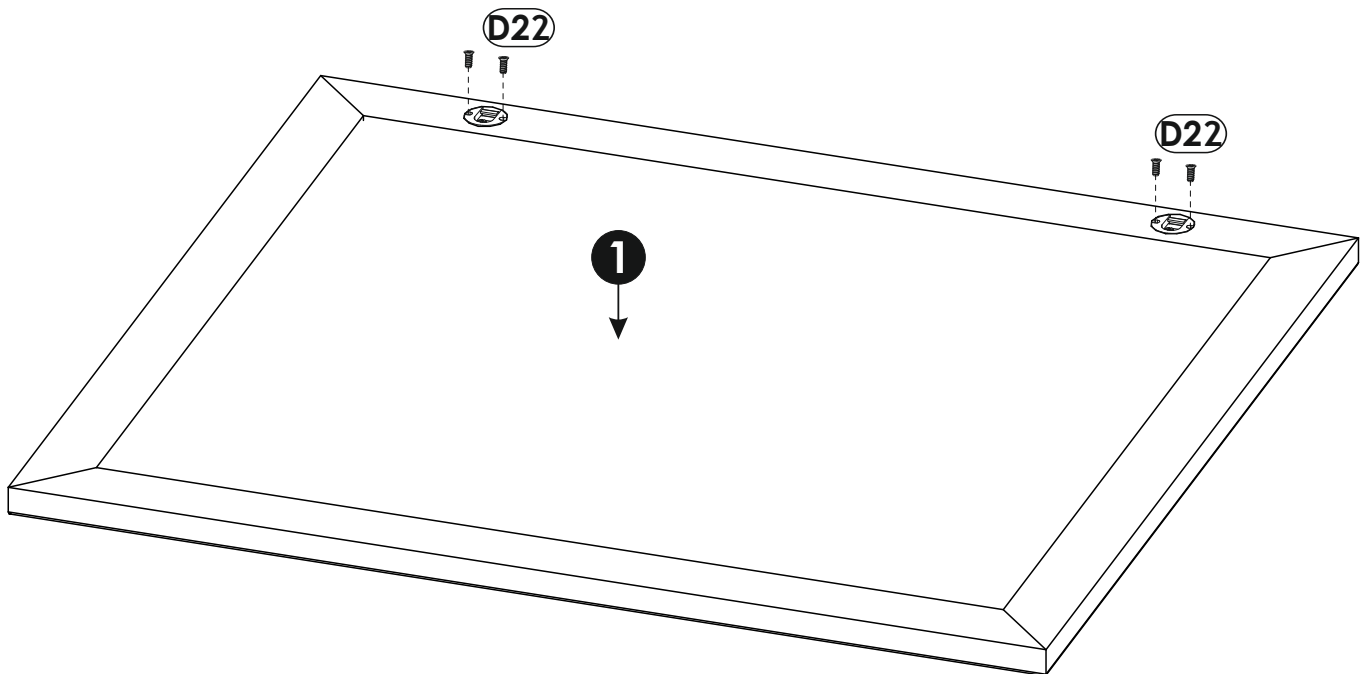
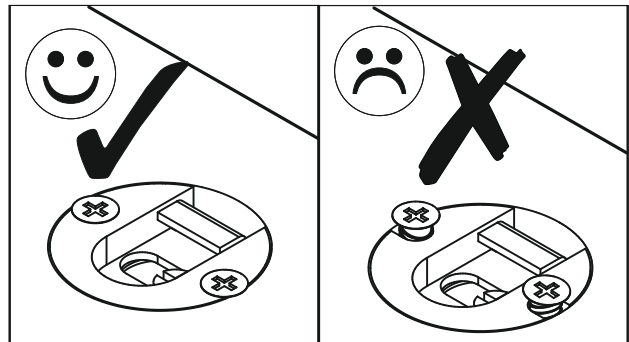
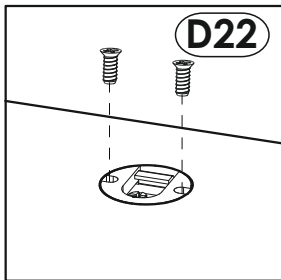
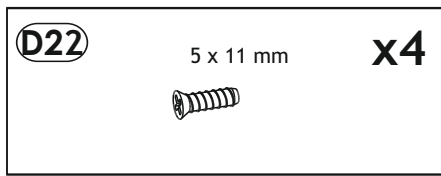

2 ▶

